

ATR - Remote Control Unit



OLED/LCD P/N 600R01-(3xx)-(xxx)

Operation and Installation

(Dokument-Nr. 01.1313.010.71e)

Change History

Revision	Date	Description of Change
1.00	15.11.2017	First release
1.01	26.02.2018	Correction in table "Technical Data"

List of the Service Bulletins (SB)

Services bulletins are to be inserted in the manual and to be put down in this table.				
SB Number	Rev. No.	Issue Date	Entry Date	Name

Contents

1	GENERAL.....	4
1.1	Symbols	4
1.2	Abbreviations	4
1.3	Customer Support.....	5
1.4	Features.....	5
2	OPERATION.....	6
3	INSTALLATION	7
3.1	Advices and Tips.....	7
3.2	Scope of delivery.....	7
3.3	Unpacking and Inspecting the Equipment	7
3.4	Mounting	8
3.5	Wiring.....	8
3.5.1	Connection Using the Provided Cable Set.....	8
3.5.2	Connections Using	9
3.5.3	Connector Pin Allocations.....	9
3.5.4	Wiring Diagram.....	10
3.6	Post-Installation Check.....	10
3.7	Accessories.....	10
3.8	Drawings	11
3.8.1	Dimensions.....	11
3.8.2	Mounting Advices	11
4	APPENDIX.....	12
4.1	Frequency/Channel-Plan.....	12
4.2	Technical Data	13
4.3	Environmental Conditions	14

1 GENERAL

This manual contains information about the physical, mechanical and electrical characteristics as well as information about installation and operation of the ATR-Remote-Control Unit for the VHF Com transceivers ATR833-II/ATR833A-II. The ATR-Remote-Control Unit is available with LCD or OLED display.

1.1 Symbols

	Advices whose non-observance can cause radiation damage to the human body or ignition of combustible materials.
---	---

	Advices whose non-observance can cause damage to the device or other parts of the equipment.
--	--

	Information
---	-------------

1.2 Abbreviations

Abb.	Name/subject	Definition
DIM	Dimming	Display Brightness
EXT	External audio input	Volume of external audio signal
INT	Intercom	Volume of board-internal intercom
MIC	Microphone	
PTT	Push-To-Talk	Key to activate radio transmission
SEL	Selection	
SQ	Squelch	Noise suppression radio reception
VOL	Volume	Volume of radio reception
VOX	Voice activation	Volume threshold for voice-activated intercom

1.3 Customer Support

In order to facilitate a rapid return of shipments, please follow the instructions of the input guide “Reshipment RMA” provided at the Service-Area within the f.u.n.k.e. AVIONICS GmbH web portal www.funkeavionics.de.



Any suggestions for improvement of our manuals are welcome. Contact: service@funkeavionics.de.



Informations on software updates are available at f.u.n.k.e. AVIONICS GmbH.

1.4 Features

- Remote Control for controlling VHF COM transceivers
 - ATR833-II
 - ATR833A-II
- Ideal for tandem seated aircraft:
 - Automatic deactivation of remote control on deactivation of radio
 - Use of radio still possible without activation of remote control
- Fully transparent remote control – everybody sees what the other does
- Direct access to the **20** frequency memories of the remote controlled radio, including their names
- Easy recall of the 10 last used frequencies
- Easy installation – plugin of one connector only.
- High contrast LCD / OLED display 128x64 dot matrix

2 OPERATION

Operation of the ATR833-II or ATR833A-II radio via the ATR-Remote-Control Unit is identical to operation on the radio itself.

The description of the controls, as well as the settings and configuration menu can be found in the manual for the ATR833-II radio (Doc. No. 01.143.010.71e) in Chapters 2 and 3.

Note:

The AUTO ON setting applies to the remote control, not the radio.

3 INSTALLATION

3.1 Advices and Tips

The following suggestions should be considered before installing

The assigned installation company could perform wiring. For diagrams refer to section 3.5 *Wiring*.

3.2 Scope of delivery

Part Number	Description
ATR-Remote-Control (ATR833RT-II)	Remote Control Unit for ATR833-II and ATR833A-II in two-knob versions
ZUB4	2x solid an 2x hollow mounting screws – for panels up to 3mm
BSKS600R4	Cable set for remote control
01.1313.010.71e	User Manual „Operation and Installation“
	EASA Form 1

3.3 Unpacking and Inspecting the Equipment

Carefully unpack the equipment. Damages due to transportation must be reported to the shipping company immediately. Save the shipping container and all packing materials to substantiate your claim

	For storage or reshipment the original packaging should be used.
---	--

3.4 Mounting

- In cooperation with a maintenance shop, location and kind of the installation are specified. The maintenance shop can supply all cables. Suitable sets of cables are available from f.u.n.k.e. AVIONICS GmbH.
- Select a position away from heat sources. Care for adequate convection cooling.
- Leave sufficient space for the installation of cables and connectors.
- Avoid sharp bends and wiring close to control cables.
- Leave sufficient lead length for inspection or repair of the wiring of the connector.
- Bend the harness at the rear connectors to inhibit water droplets (formed due to condensation) from collecting in the connector.
- Remove rotary knobs before mounting:
 - Lift-off caps of the rotary knobs with an appropriate tool
 - Loosen screw and remove rotary knob
 - Insert cap correctly orientated!
- The equipment is fixed front-laterally with four 6-mm through-hole screws in a 57 mm cut-out.
- For mounting details/drawing refer to chapter 3.8.2 Mounting Advices.

3.5 Wiring

3.5.1 Connection Using the Provided Cable Set

Simply connect one D-SUB connector to the ATR-Remote-Control and the other D-SUB connector to the mating connector of the remote controlled radio's cable set.

The ATR-Remote-Control now gets the power from the remote controlled device; thus it's operation depends onto the operation of the remote controlled device.

3.5.2 Connections Using

Power Supply (Power, GND): AWG18 (0,96 mm²)

Signals: AWG22 (0,38 mm²)

The conductors must be approved for aircraft use.

RX and TX should be shielded individually, or at least be pair-twisted and shielded together.

The light input should

- in aircraft with lighting bus connected to this,
- in the more common case of aircraft without lighting bus connected to the power supply.

	<p>When powering the remote control not by the output of the switched power output of the remote controlled device but directly by the aircraft's power supply, the power input line (+UB) must be equipped with an external fuse (1 Amp. slow-blow).</p>
--	---

3.5.3 Connector Pin Allocations

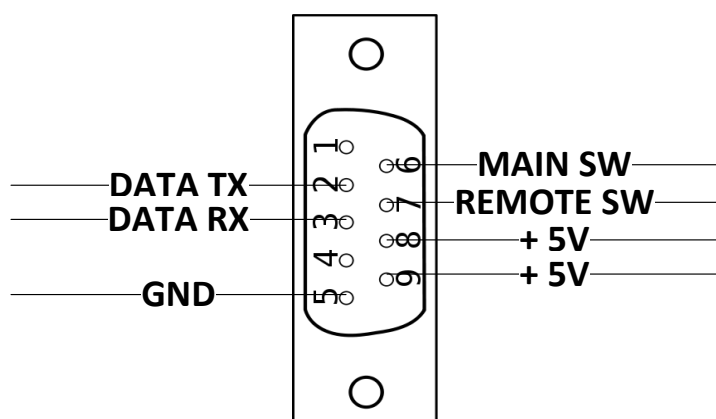

Connector side
(Devices backside)

3.5.4 Wiring Diagram

The connection between the remote control and the 9-pin D-SUB connector of the ATR833-II cable can be realized by a standard 9-wire D-SUB cable.

The connection between the 9-pin D-SUB remote connector and the radio (ATR833-II, ATR833A-II) is shown in the following figure.

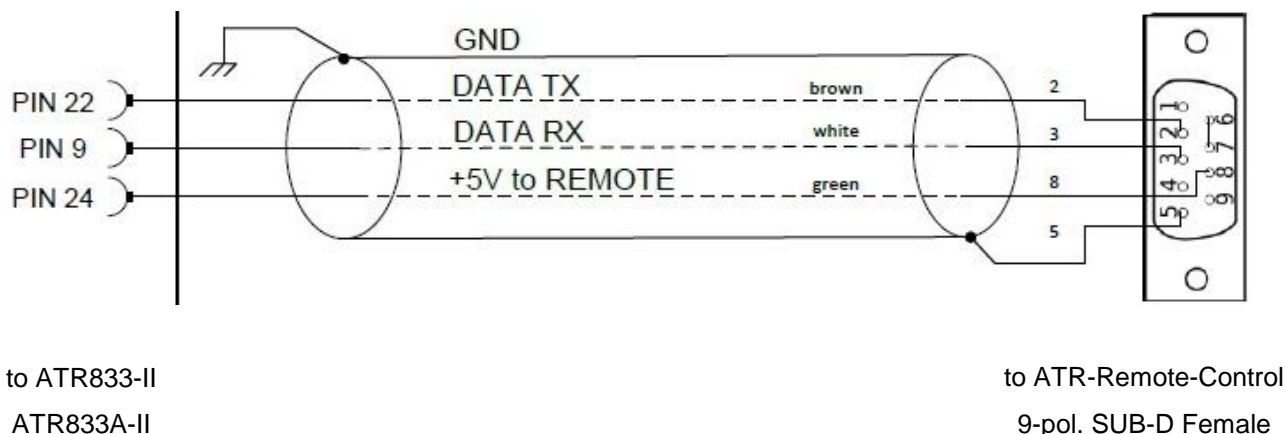

3.6 Post-Installation Check

When installation is completed all steering and control functions of the aircraft are to be examined, in order to exclude disturbances by the wiring.

For performing an installation check of the remote control, first switch on the remote controlled device, and subsequently the ATR600RT. After the startup-message, which includes the device type, the display should first show the message "SYNCHRONIZING", followed by changing to the normal mode display including the two frequencies, within a few seconds. The remote control is now ready for use.

3.7 Accessories

Suitable accessories like cable sets, connectors or switches can be purchased at our online shop on www.funkeavionics.de.

3.8 Drawings

3.8.1 Dimensions

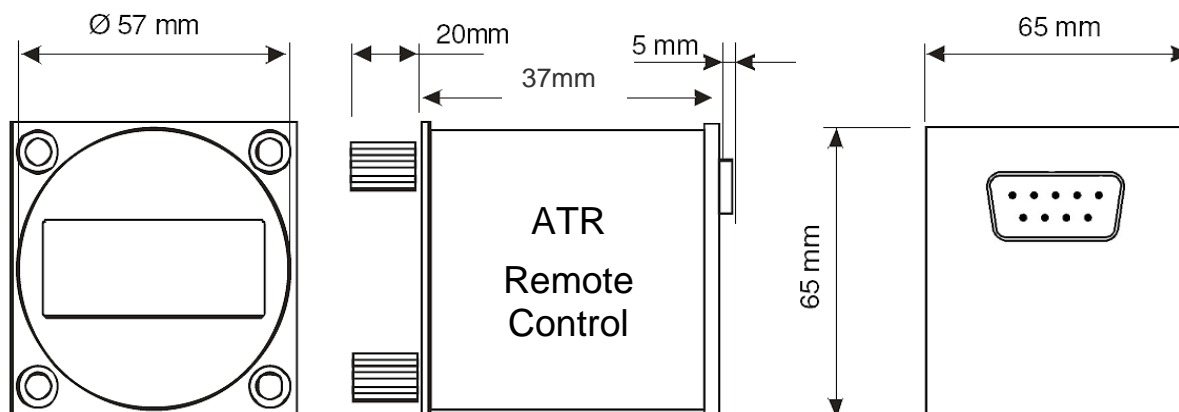

3.8.2 Mounting Advices

For mounting in panels with a thickness of 3–5 mm longer screws are available (Order No. ZUB5: includes 2x solid und 2x hollow mounting screws):

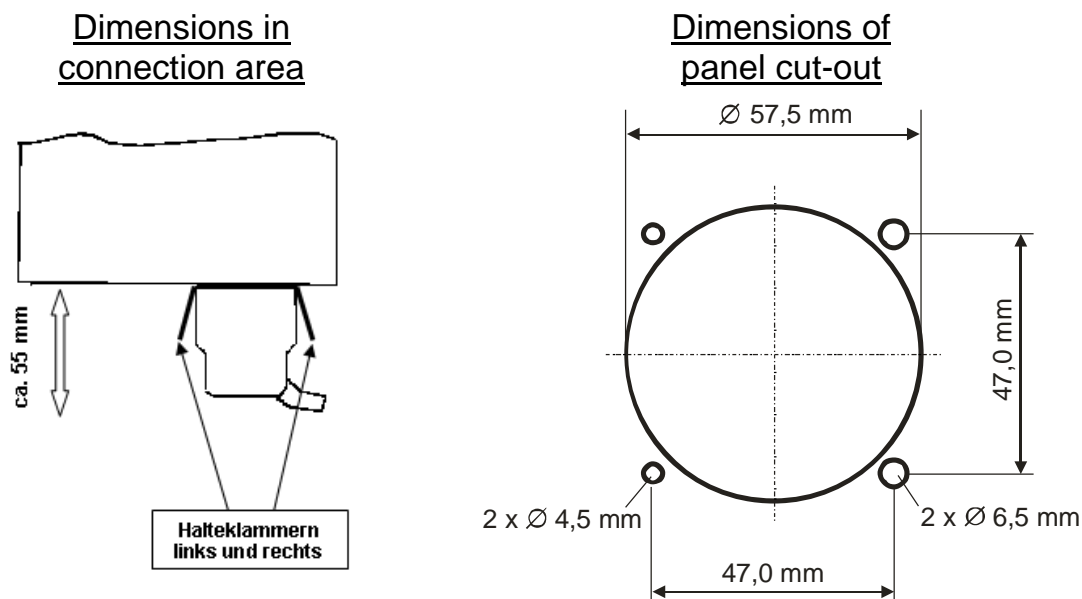

	No screws may be turned in more than max. 15mm into the device – even if no hard limit is noticeable!
--	--

	The D-SUB-Connector has to be clamped with both spring locks. It is recommended to additionally secure them with a cable tie.
--	---

4 APPENDIX

4.1 Frequency/Channel-Plan

In the following table examples for operating and displayed frequencies in the range between 118.000 ... 118.100 MHz are given. This table can be continued to 136.975 MHz following the same scheme.

Operating Frequency (MHz)	Channel Width (kHz)	Displayed Frequency in 8.33/25 kHz Mode	Displayed Frequency in 25 kHz Mode
118.0000	25	118.000	118.000
118.0000	8.33	118.005	
118.0083	8.33	118.010	
118.0166	8.33	118.015	
118.0250	25	118.025	118.025
118.0250	8.33	118.030	
118.0333	8.33	118.035	
118.0416	8.33	118.040	
118.0500	25	118.050	118.050
118.0500	8.33	118.055	
118.0583	8.33	118.060	
118.0666	8.33	118.065	
118.0750	25	118.075	118.075
118.0750	8.33	118.080	
118.0833	8.33	118.085	
118.0916	8.33	118.090	
118.1000	25	118.100	118.100
118.1000	8.33	118.105	
etc.	etc.	etc.	etc.

4.2 Technical Data

GENERAL	
COMPLIANCE	JTSO-2C37e,ED-23B Class 4, 6 JTSO-2C38e,ED-23B Class C, E TSO-C37d, RTCA DO-186A Class 4, 6 TSO-C38d, RTCA DO-186A Class C, E LBA.O.10.911/115 JTSO
DIMENSIONS	Height: 65 mm (2,56 in) Width: 65 mm (2,56 in) Depth: 86 mm (3,27 in) behind the panel
WEIGHT	0.43 lbs (0.20 kg)
MOUNTING	Panel Mounted
TEMPERATURE RANGES OPERATION STORAGE	-20 °C ... +55 °C,30 min at +70 °C -55 °C .. +85 °C
MAX. HEIGHT	35.000ft
VIBRATION	DO-160D, Cat. S, Vibration Curve M
HUMIDITY	RTCA DO-160D, Cat. A
SHOCK	6 G operation 20 G crash safety
RTCA DO-160D ENV.CAT.	[C1Z]CAA[SM]XXXXXXZBAAA[YY]M[B3F3]XXA
POWER SUPPLY	5,0 VDC (3,4 VDC – 5,9 VDC) 120 mA (typ.)
CURRENT CONSUMPTION	600 mW
COMPASS-SAFE DISTANCE	30cm

4.3 Environmental Conditions

Characteristic DO-160D	Section	Cat	Condition
Temperature / Altitude	4.0		
Low ground survival temperature	4.5.1	C1	- 55°C
Low operating temperature	4.5.1		- 20°C
High ground survival Temperature	4.5.2		+ 85°C
High Short-time Operating Temperature	4.5.2		+ 70°C
High Operating Temperature	4.5.3		+ 55°C
In-Flight Loss of Cooling	4.5.4	Z	No auxiliary cooling required
Altitude	4.6.1	C1	35 000 ft
Temperature Variation	5.0	C	2°C change rate minimum per minute
Humidity	6.0	A	
Shock	7.0	A	6 G operational shocks 20 G Crash Safety Test Type R in all 6 directions
Vibration	8.0	S	Vibration Curve M
Explosion Proofness	9.0	X	No test required
Water Proofness	10.0	X	No test required
Fluids Susceptibilities	11.0	X	No test required
Sand and Dust	12.0	X	No test required
Fungus Resistance	13.0	X	No test required
Salt Spray	14.0	X	No test required
Magnetic Effect	15.0	Z	Less than 0,3 m Compass Safe Distance
Power Input (DC)	16.0	B	
Voltage Spike Conducted	17.0	A	

Characteristic DO-160D	Section	Cat	Condition
Audio Frequency Conducted Susceptibility	18.0	A	
Induced Signal Susceptibility	19.0	A	
Radio Frequency Susceptibility	20.0	YY	
Emission of RF Energy	21.0	M	
Lightning Induced Transient Susceptibility	22.0	B3 F3	
Lightning Direct Effects	23.0	X	No test required
Icing	24.0	X	No test required
Electrostatic Discharge (ESD)	25.0	A	

Notes:

f.u.n.k.e.

AVIONICS GMBH

f.u.n.k.e. AVIONICS GmbH

Heinz-Strachowitz-Str. 4
DE-86807 Buchloe
Germany

phone.: +49-8241 80066 0

fax.: +49-8241 80066 99

E-mail:

service@funkeavionics.de

www.funkeavionics.de